

Smart Lock User Manual



Special Attention:

1. Please charge for the battery when low wattage alarm.
2. Reading this manual carefully before installation, and keep it for future reference.

1. Lock Structure



2. Installation

2.1 Installation Diagram

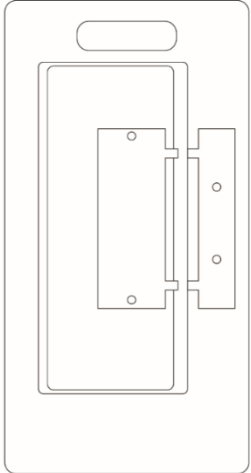
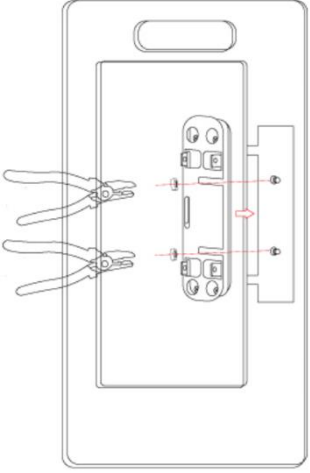
Step 1 Install Sticky Sheets	Step 2 Install Striking Box
	

Step 3 Install Striking Box Case

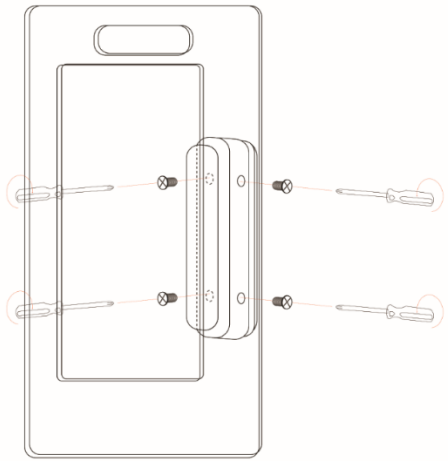

Step 4 Install Front Panel

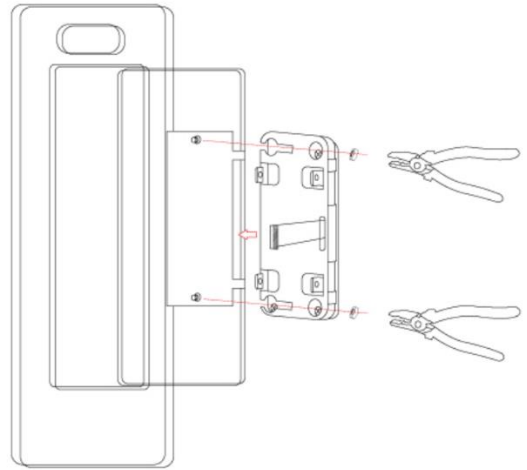

Step 5 Connect Front and Back Panels

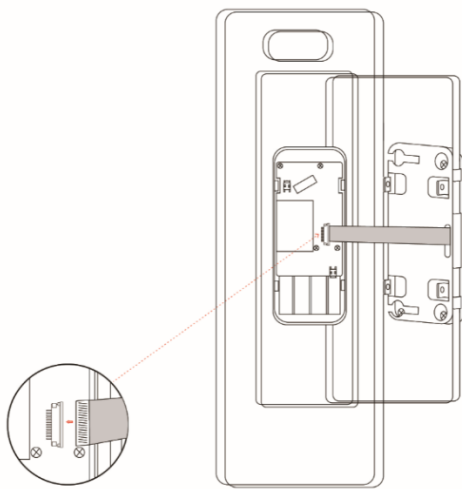

Step 6 Install Back Panel

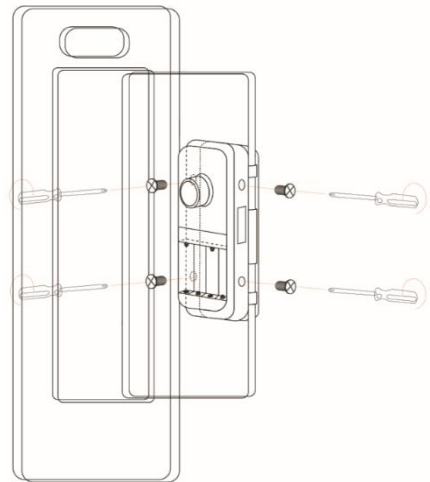

Step 7 Install Batteries

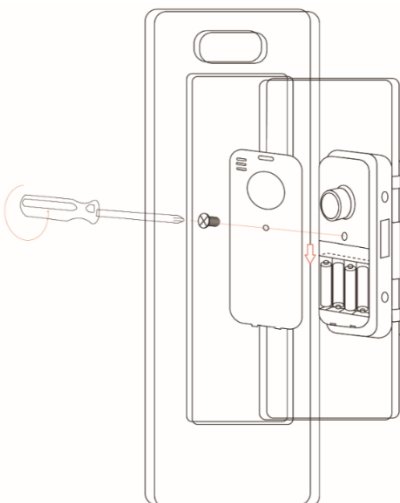

3. Specifications

Suitable for Models	E15
Materials	Metal
Lock Size	162*63mm
Lock Weight	2.5KG
Unlocking Way	Bluetooth Fingerprint Password Card
Colour	Black
Doors Applicable	Glass Door
Working Voltage	6V/4x AA Batteries
Door Thickness to Fit	10-15mm
Data Capacity	Unlimited
Fingerprint Sensor	Semiconductor
Working Temperature	-25°C-60°C
Working Humidity	20%-90%
Low Wattage Alarm	Less than 4.5V
Card Type	MF1 Card

System Initialization

Open the cover plate of the front panel ,long press the "Reset" button on the back panel for 5s, press "000#",and the initialization is complete

When the reset is complete, the language will change to Chinese. You can modify the language in the following ways:

Step 1:input*39#

step 2:input admin passcode 123456#

step 3: input 1# Chinese

input 2# English



4. Registration



4.1 Connect lock to the phone

- 1) Android mobile phone, please scan the left QR code as above
- 2) Apple mobile phone, please scan the right QR code as above
- 3) You can also search for TTLock in the APP store for download
- 4) Register a new account (phone number or email) or login with an existing account.
- 5) Touch the lock screen to light, click "+ Add Lock"
- 6) The lock nearby will appear on the phone screen, Click "+"
- 7) Re-name the lock
- 8) The lock added successfully

A screenshot of the application's login/register screen. At the top, there are two buttons: "Login" and "Register". The "Register" button is highlighted with a red rectangular box. Below the buttons is a blue hand icon with a keyhole. Underneath, there are two input fields: "Phone number/Email" and "Password". At the bottom, there is a grey "Login" button and a blue link for "Forgot Password?".

1-1

A screenshot of the registration form. At the top, there is a blue header with a back arrow and the word "Register". Below the header are two tabs: "Phone" (selected) and "Email". The form contains several input fields: "Country/Region" (pre-filled with "American Samoa+1684"), "Enter your Phone number", "Password between 6-20 chars", and "Confirm Password". At the bottom, there is a "Verification Code" field and a "Get Code" button. A grey "Register" button at the very bottom is highlighted with a red rectangular box.

1-2

A screenshot of the application's login screen. At the top, there are two buttons: "Login" and "Register". Below the buttons is a blue hand icon with a keyhole. Underneath, there are two input fields: a phone number field (pre-filled with "18520265893") and a "Password" field. At the bottom, there is a blue "Login" button highlighted with a red rectangular box and a blue link for "Forgot Password?".

1-3

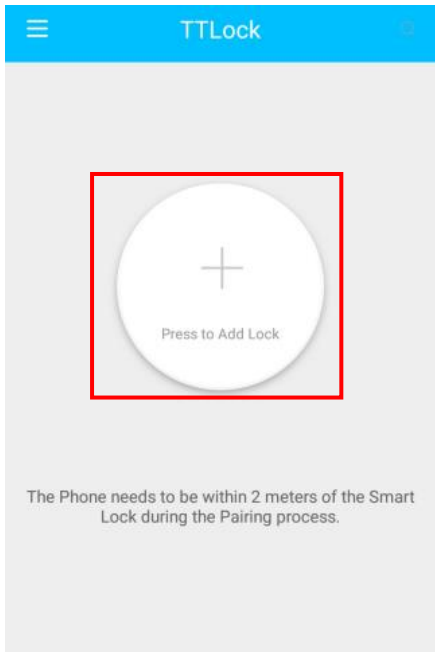

1-4

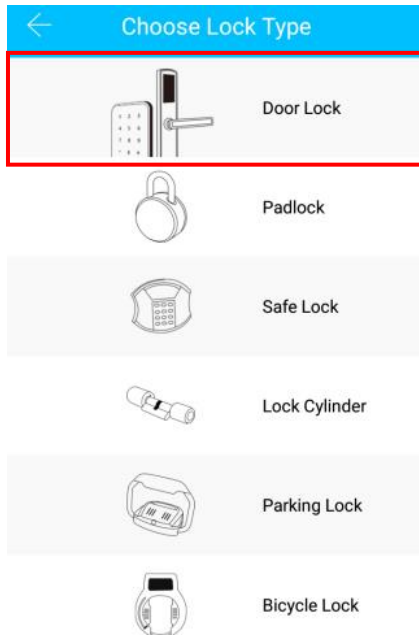

1-5

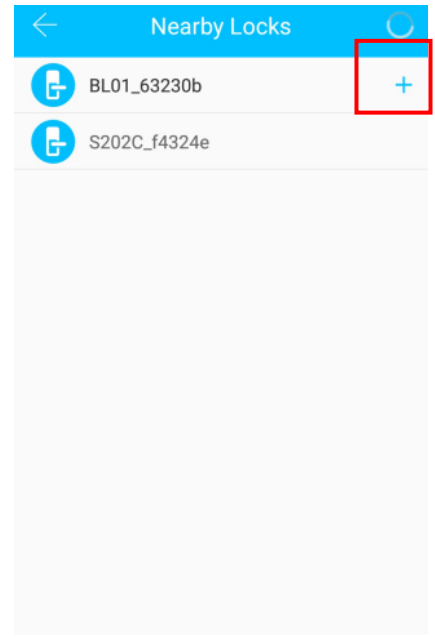

1-6

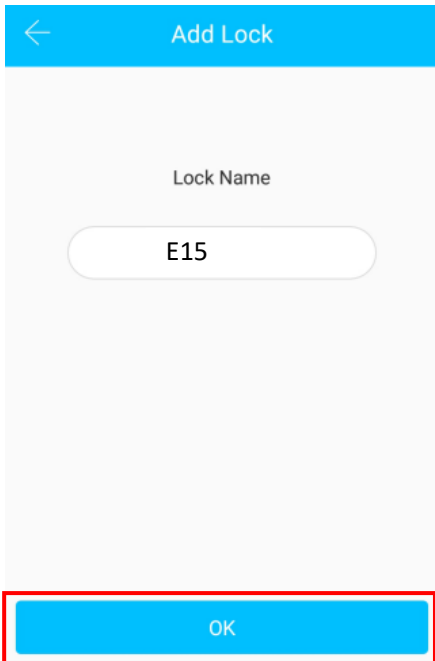

1-7

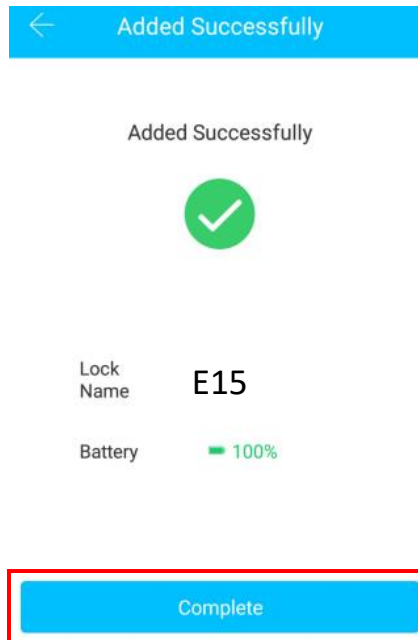

1-8

4.2 User Management

4.2.1 Bluetooth management

After mobile phone and door lock connected, Click "  " as show as figure2-1 to unlock.(the phone is within 5meters from the door lock)

4.2.2 Remote control management(Optional)

After confirming that your phone and door lock are connected to the gateway, Click "  " as show as figure 2-1 to unlock. You can unlock it anywhere you have a network. (How to set up the gateway to connect to your phone refer to step 5.3)

4.2.3 e-Key management

Click on the "  " as shown in figure 2-1, you can send the eKey to other users of TTlock to authorize the unlock (the receiver must be download the APP and resiter an account) → Enter recipient's account of TTlock, set the name and effective time of the eKey as shown in figure 2-2 → Send → The recipient's account has bluetooth unlock permission

4.2.4 The Admin password management

Click "  " as shown in figure 2-1 → See Basic → Admin Passcode as shown in finger2-3 → input Passcode on the keypad of lock → "#" to unlock.



4.2.5 Dynamic password management

Click "  " as shown in finger 2-1 → finger 2-4 You can set the effective time and effective number of passwords → Generate password → Input password to unlock.



4.2.6 Unlock records

Click "  " as shown in finger 2-1 → you can query your unlock record as shown in finger 2-5

4.2.7 Fingerprint management

Click "  " as shown in finger 2-1 → Click "  " → Add Fingerprint → set the name and effective time of the fingerprint → Start → Place your finger on the sensor follow the instructions → Add fingerprint OK → Place your fingerprint on the sensor to unlock.

4.2.8 IC Cards management

Click "  " as shown in finger 2-1 → Click "  " → Add IC Cards as finger 2-6

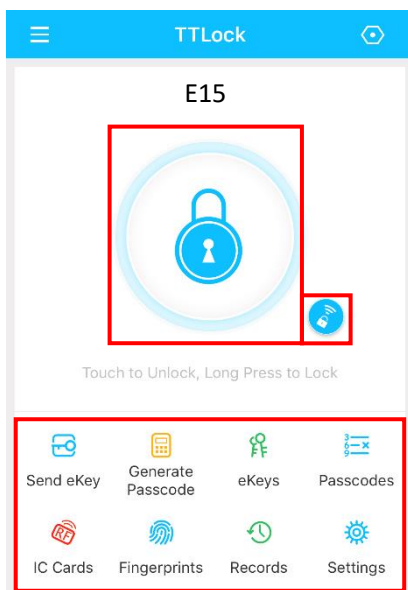

2-1

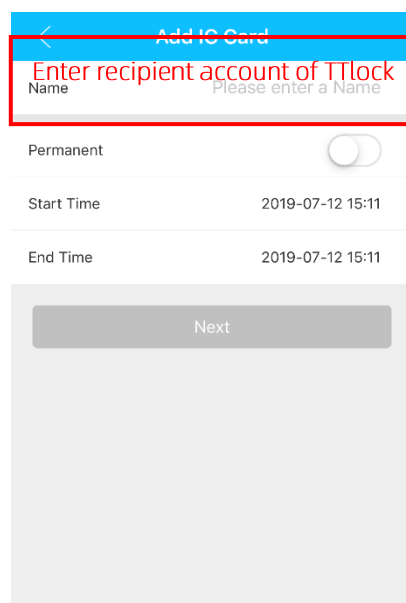

2-2

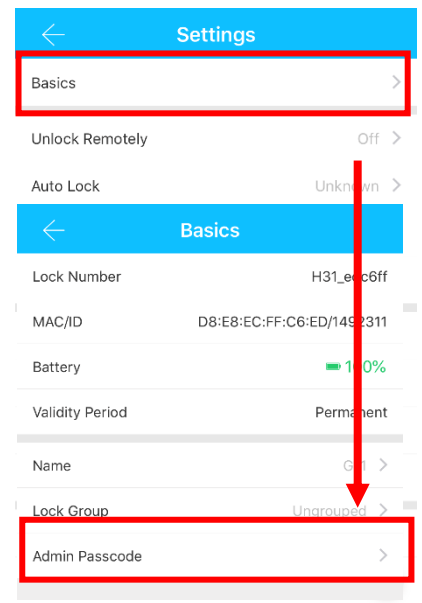

2-3

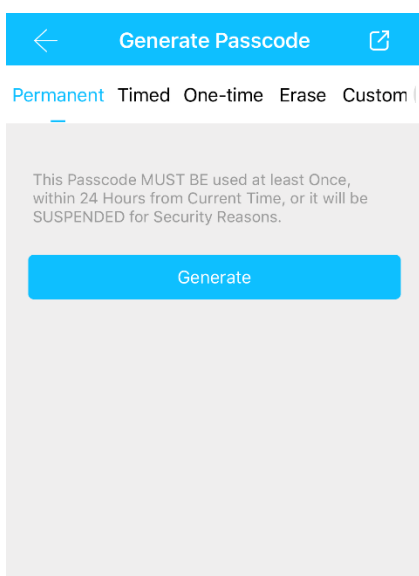

2-4

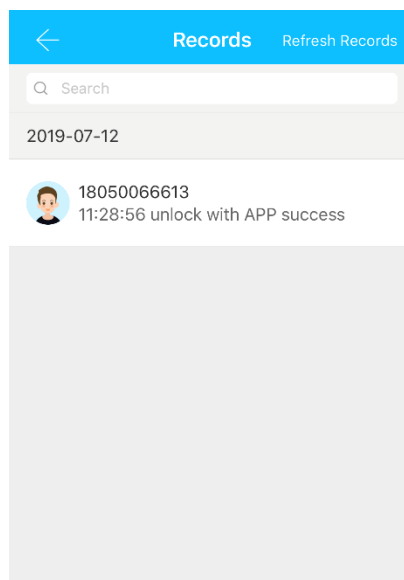

2-5

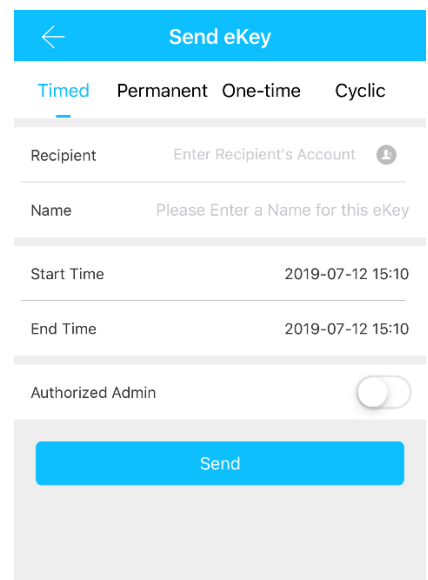



2-6

4.3 Add Gateway(Optional)

Light Status



When the gateway is powered on:

-  Light flashes alternately in red and blue: Stand-by mode, ready for pairing
-  Blue light: Working mode
-  Red light: Network failure

Pair the Gateway with APP

1 Activate the APP

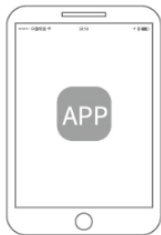

2 Press “≡”



3 Select [Gateway]

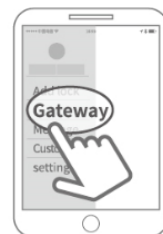

4 Select [G2]

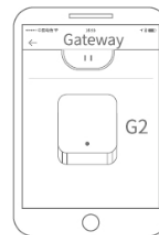

5 Plug in the gateway and power it on, while the light flashes alternately in red and blue

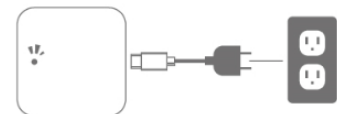

6 Press “+” sign



7 Add Gateway







8 Select the network and fill in the password



9 Add complete

⚠ Notice: If times out, please power off and try it again.

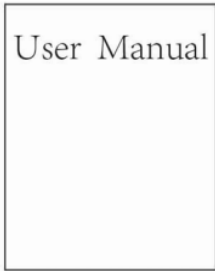
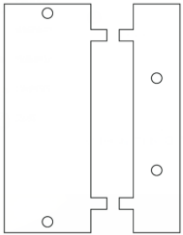
Packing List

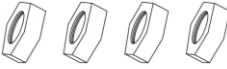
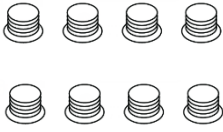
Picture				
Name	Main Panel	Striking Box	User Manual	Sticky Sheet
Quantity	1	1	1	2
Picture				
Name	Card	Nut	Screws	
Quantity	3	4	8	

Guarantee

Customer name: _____

Customer calls : _____

Purchase date : _____

Product name : _____

Product model : _____

Note:

- 1) Please keep this card so that you can use it when you need warranty service.
- 2) We provide you with a one-year warranty from the date of purchase.
- 3) This warranty service is valid for customers in any country in the world.