



YLI ELECTRONIC



Intelligent Sturdy Electric Bolt Lock with Handle

Model: YB-660

Parameters

Lock Body	285Lx30Wx40D(mm)
Magnetic Plate	100Lx30Wx3D(mm)
Bolt	16(prolongation)*20(diameter)(mm)
Voltage	12VDC
Current	Start 2200mA,Standby 400mA
Time Delay	0/3/6/9sec
Feature	Fail secure
Signal Output	Door signal(NO/COM) Lock signal(NO/NC/COM)
Detection Distance	Within 3-8mm
Suitable for	Wooden door, metal door, fireproof door, glass door
Material	304 stainless steel, wire draw finishing
Weight	1.25kg

Dimensions

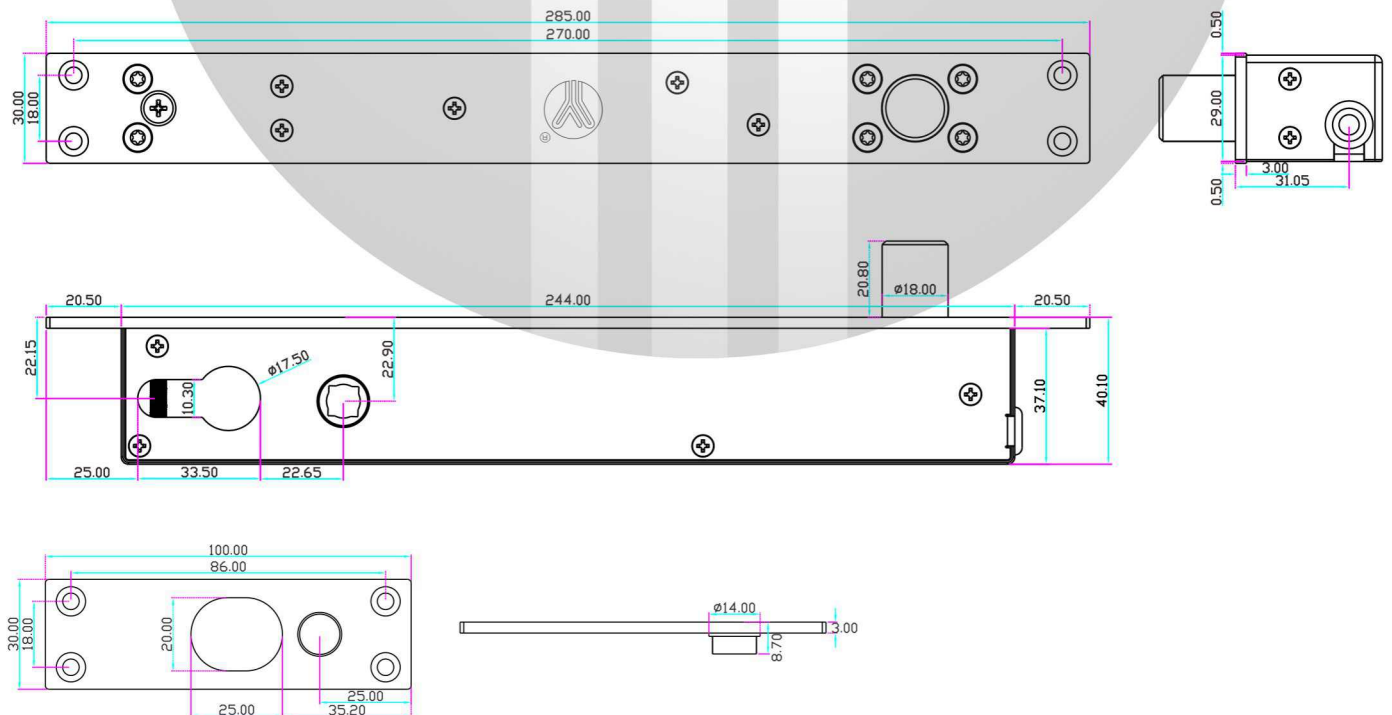

Optional Accessory

Single side cylinder or both side cylinder, other sizes are available too: 80/90/100/110/120mm.

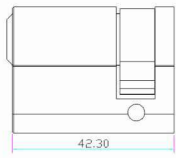
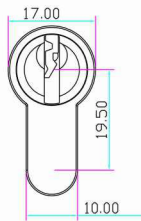

Single side cylinder

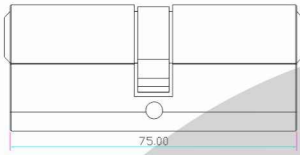
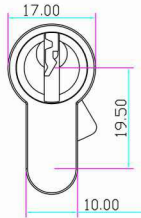

Double side cylinder

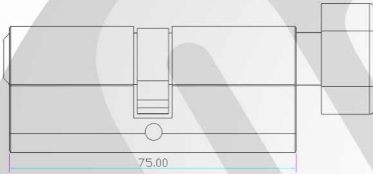
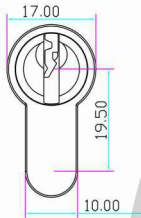

Single side cylinder with Thumb

Wiring Diagram

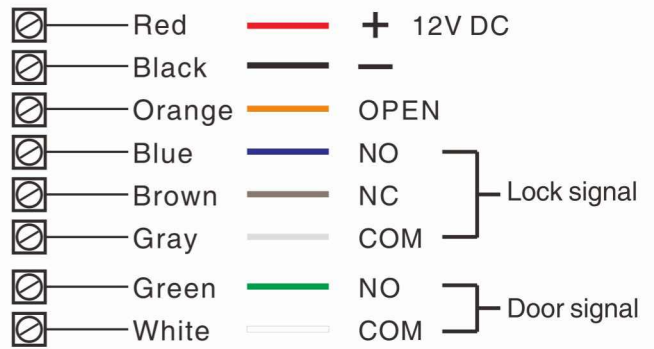

Time Delay

Adjust the delay time for locking automatically 0/3/6/9 secs.



0.0 SEC



6.0 SEC



3.0 SEC



9.0 SEC

Installation steps

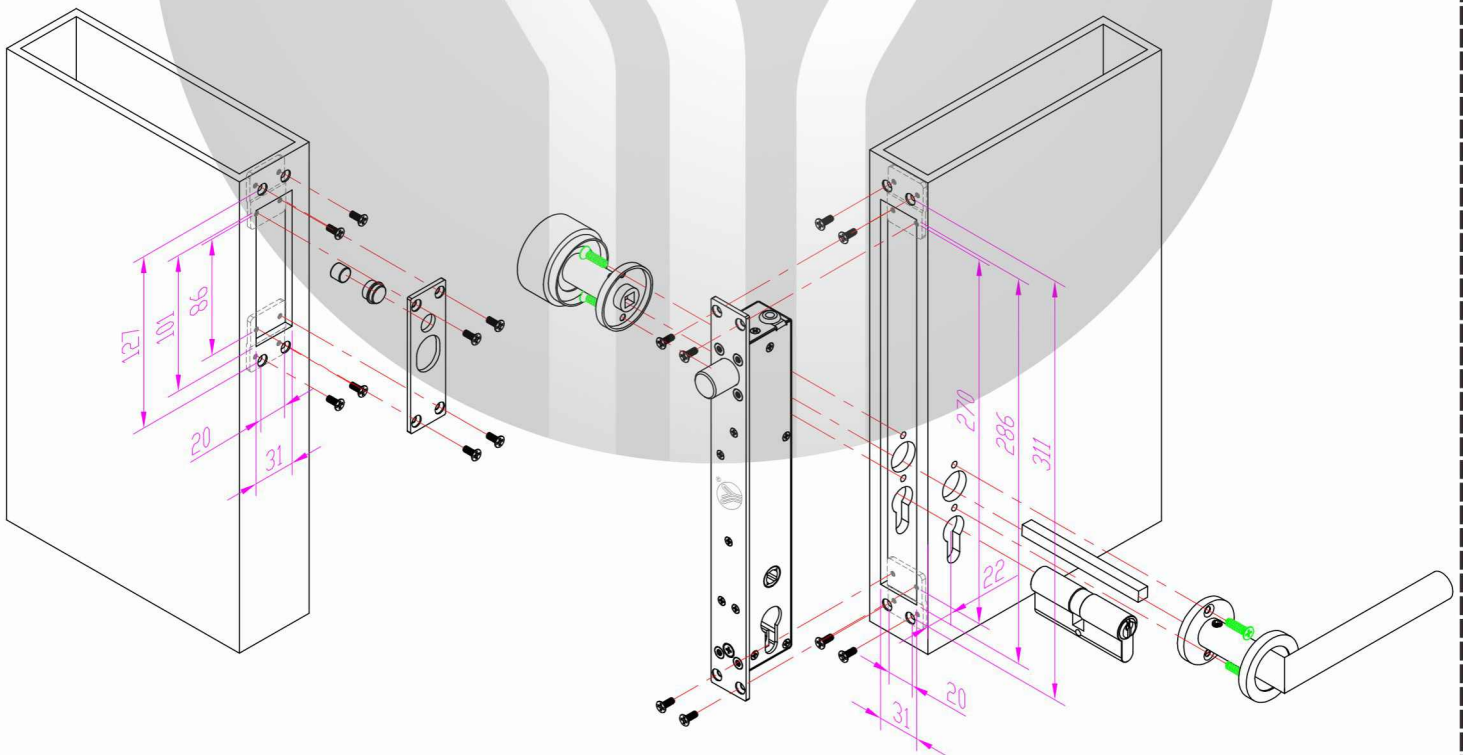

Attention: Bolt should not be upward when install.